

# LAUFEN

Bathroom Culture since 1892  [www.laufen.com](http://www.laufen.com)



**twin**prime

## twinprime

Warum lieben wir Klassiker? Weil sie schlicht gut sind. twinprime ist seit Jahren der Inbegriff für Eleganz und raffinierte Technik. Das neue Mischsystem mit Mengen- und Temperaturlimitierung bietet zudem Schutz vor Verbrühung. Und übrigens: twinprime flex, mit dem biegbaren Auslauf, ist Preisträger des red dot design award 2008. twinprime – Eleganz und Technik. Zwei in einem.

Why do we love classic designs? Because their simplicity reigns supreme. twinprime has for years been a byword for elegance and sophisticated technology. The new mixer system with flow and temperature limiters offers additional protection against scalding. What's more: twinprime flex, the model with the flexible outlet, is a winner of the 2008 red dot design award. twinprime – Elegance and technology. Two in one.

Pourquoi aimons-nous tant les grands classiques ? Parce qu'ils sont tout simplement beaux. twinprime est depuis de nombreuses années le symbole même de l'élégance et d'une technique raffinée. Les nouveaux mitigeurs avec limitation de débit et de température offrent également une protection contre les brûlures. Par ailleurs le modèle twinprime flex à goulot flexible a été distingué par le red dot design award 2008. twinprime – élégance et technique. Deux en un.

Waarom wij van klassiekers houden? Omdat zij rondit goed zijn. Al jaren is twinprime synoniem van elegantie en verfijnde techniek. Het nieuwe mengsysteem met debiet- en temperatuurbegrenzing biedt nu ook bescherming tegen verbranding. En verder: twinprime flex, de kraan met de soepele uitloop, is bekroond met een red dot design award 2008. twinprime – elegantie en techniek. Twee in één.





twinn prime



31132.1.004.221.1  
Waschtischmischer  
Patrone Quattro-G  
Ausladung 175 mm  
Schwenkauslauf  
Ablaufventil

Basin single-lever mixer  
cartridge Quattro-G  
spout reach 175 mm  
with swivel spout and  
pop-up waste

Mitigeur de lavabo  
cartouche Quattro-G  
saillie 175 mm  
goulot mobile  
vidage

Wastafelmengkraan  
keramische kardoos Quattro-G  
sprong 175 mm  
draaibare uitloop  
waste

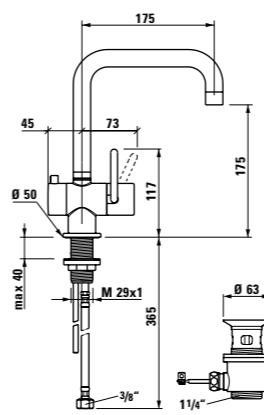

31132.1.004.211.1  
Waschtischmischer  
Patrone Quattro-G  
Ausladung 135 mm  
Schwenkauslauf  
Ablaufventil

Basin single-lever mixer  
cartridge Quattro-G  
spout reach 135 mm  
with swivel spout and  
pop-up waste

Mitigeur de lavabo  
cartouche Quattro-G  
saillie 135 mm  
goulot mobile  
vidage

Wastafelmengkraan  
keramische kardoos Quattro-G  
sprong 135 mm  
draaibare uitloop  
waste

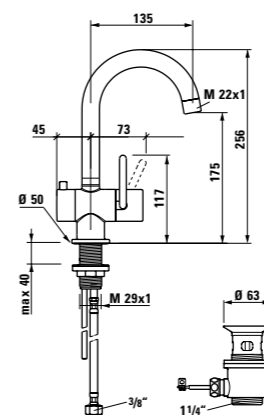

31132.1.004.111.1  
Waschtischmischer  
Patrone Quattro-G  
Ausladung 130 mm  
fester Auslauf  
Ablaufventil

Basin single-lever mixer  
cartridge Quattro-G  
spout reach 130 mm  
with fixed spout and  
pop-up waste

Mitigeur de lavabo  
cartouche Quattro-G  
saillie 130 mm  
goulot fixe  
vidage

Wastafelmengkraan  
keramische kardoos Quattro-G  
sprong 130 mm  
vaste uitloop  
waste

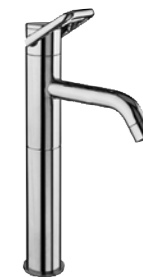
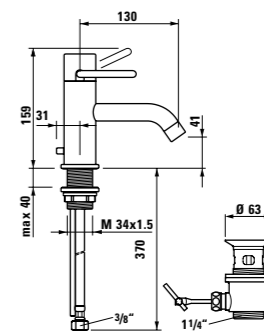

31132.1.004.120.1  
Standsäulenmischer  
Patrone Quattro-G  
Ausladung 150 mm  
fester Auslauf  
Ablaufventil

Standing column mixer (basin)  
cartridge Quattro-G  
spout reach 150 mm  
with fixed spout and  
pop-up waste

Mitigeur de lavabo  
à bec rehaussé  
cartouche Quattro-G  
saillie 150 mm  
goulot fixe  
vidage

Mengkraan op kolom  
keramische kardoos Quattro-G  
sprong 150 mm  
vaste uitloop  
waste

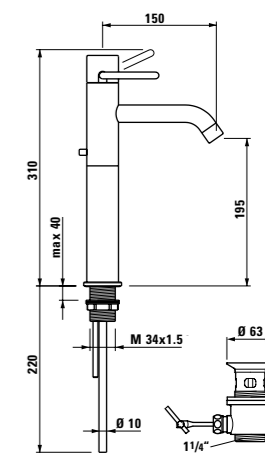



34132.1.004.111.1  
**Bidetmischer**  
**Patrone Quattro-G**  
**Ausladung 110 mm**  
**Ablaufventil**

*Bidet single-lever mixer cartridge Quattro-G spout reach 110 mm with pop-up waste*

*Mitigeur de bidet cartouche Quattro-G saillie 110 mm vidage*

*Bidetmengkraan keramische kardoos Quattro-G sprong 110 mm waste*

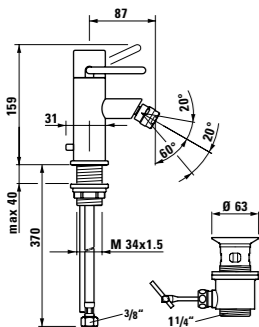

31132.6.004.120.1  
**UP-Wandmischer**  
**Ausladung 225 mm**  
**(das Rohbauset LW muss separat bestellt werden)**

*Concealed basin wall mixer spout reach 225 mm (rough-in set LW to be ordered separately)*

*Mitigeur de lavabo mural encastré saillie 225 mm (set de montage LW à commander séparément)*

*Inbouw-wandmengkraan sprong 225 mm (montageset LW moet apart besteld worden)*

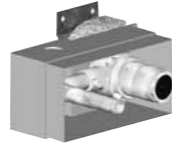
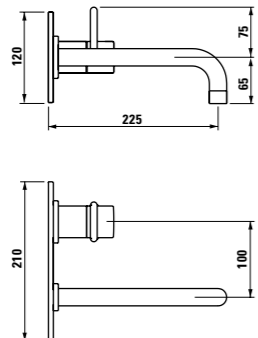

37698.1.000.000.1  
**Rohbauset LW**  
**für UP-Wandmischer**  
**Quadrige und Twin**  
**Patrone Quattro-G**

*Rough-in set LW for concealed basin wall mixer Quadrige and Twin cartridge Quattro-G*

*Set de montage LW pour mitigeur de lavabo mural encastré Quadrige et Twin cartouche Quattro-G*

*Montageset LW voor inbouw-wandmengkraan Quadrige en Twin keramische kardoos Quattro-G*

3.7732.4.004.050.1  
**Verlängerungsset**

*Extension set*  
*Set de rallonge*  
*Verlengset*

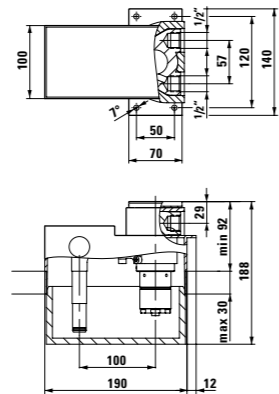

33132.7.004.144.1  
**Duschkraan**  
**komplett**  
**Patrone Ecototal**  
**Handbrause arwa-style Uno und**  
**Kunststoffschlauch 1800 mm**

*Shower single-lever mixer complete cartridge Ecototal arwa-style Uno handspray and flexible hose 1800 mm*

*Mitigeur de douche complet cartouche Ecototal douchette arwa-style Uno et flexible synthétique 1800 mm*

*Douchemengkraan compleet keramische kardoos Ecototal handdouche arwa-style Uno en kunststof doucheslang 1800 mm*

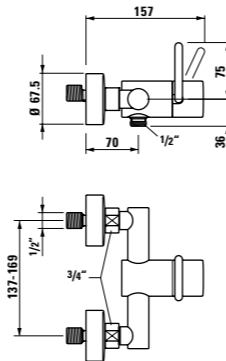

32132.7.004.144.1  
**Bademischer, komplett**  
**Patrone Ecototal**  
**Handbrause arwa-style Uno und**  
**Kunststoffschlauch 1800 mm**

*Bath single-lever mixer, complete cartridge Ecototal arwa-style Uno handspray and flexible hose 1800 mm*

*Mitigeur de bain, complet cartouche Ecototal douchette arwa-style Uno et flexible synthétique 1800 mm*

*Badmengkraan, compleet keramische kardoos Ecototal handdouche arwa-style Uno en kunststof doucheslang 1800 mm*

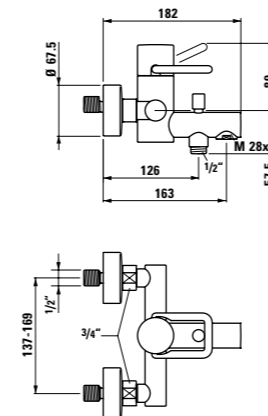

32113.6.004.000.1  
**Fertigmontage-Set für Unterputz-**  
**Bademischer, Simibox**

*Set for concealed bath/shower mixer, with diverter, Simibox*

*Habillage extérieur pour mitigeur de bain encastré, Simibox*

*Set-Eindmontage voor Inbouw-Badmengkraan*

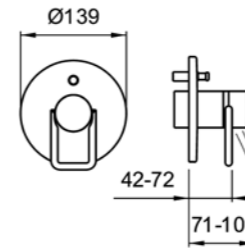

33113.6.004.000.1  
**Fertigmontage-Set für Unterputz-**  
**Duschenmischer, Simibox**

*Set for concealed shower mixer, Simibox*

*Habillage extérieur pour mitigeur de douche encastré, Simibox*

*Set-Eindmontage voor Inbouw-Douchemengkraan*

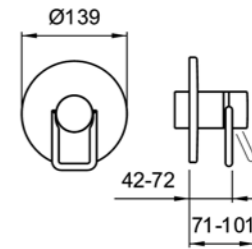

37898.0.000.000.1  
**Simibox**  
**Unterputz-Einbaukörper für**  
**Bade- und Duschenmischer**

*Concealed box for bath and shower mixer*

*Corps encastré pour mitigeur de bain et de douche*

*verborgen lichaam voor Bad- en Douchemengkraan*

37998.0.003.000.1  
**Montagehilfe für Simibox**

*Mounting aid for Simibox*  
*Aide de montage pour Simibox*  
*Vergadering steun voor Simibox*

37998.0.000.500.1  
**Flansch für Simibox**

*Flange aid for Simibox*  
*Bride pour Simibox*  
*Flens voor Simibox*

37998.0.000.050.1  
**Verlängerungsset L = 25 mm**

*Extension set L = 25 mm*  
*Rallonge L = 25 mm*  
*Verlengset L = 25 mm*

37998.0.000.060.1  
**Verlängerungsset L = 50 mm**

*Extension set L = 50 mm*  
*Rallonge L = 50 mm*  
*Verlengset L = 50 mm*



32132.4.004.284.1  
**Wannenfüllkombination 4-Loch  
Abdeckplatte, gerade  
Patrone Ecototal**

Roman tub filler 4-holes  
on cover plate, straight  
cartridge Ecototal

Garniture pour baignoire 4-trous  
plaque rectangulaire  
cartouche Ecototal

Badrandcombinatie 4-gats  
rechte afdekplaat,  
keramische kardoes Ecototal

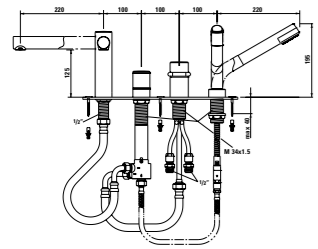

32132.1.004.130.1  
**Standsäulen-Bademischer  
Ausladung 220 mm  
max. Höhe 780 mm  
ohne Rohbaukörper  
Patrone Ecototal**

Column bath mixer  
spout 220 mm  
maximum height 780 mm  
without technical bloc  
cartridge Ecototal

Mitigeur de bain sur colonne  
saillie 220 mm  
hauteur max 780 mm  
sans bloc technique  
cartouche Ecototal

Staande badmengkraan  
sprong 220 mm  
max. hoogte 780 mm  
zonder technisch blok  
keramische kardoes Ecototal

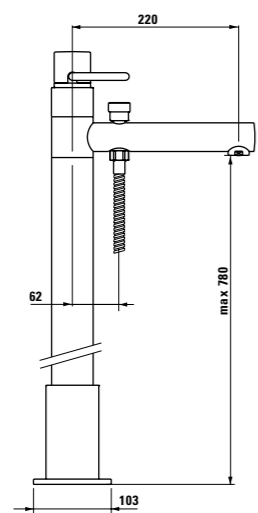

37098.5.000.000.1  
**Rohbaukörper zu  
Standsäulen-Bademischer  
Patrone Ecototal**

Technical bloc for  
column bath mixer

Bloc technique pour  
mitigeur de bain sur colonne

Technisch blok voor  
staande badmengkraan

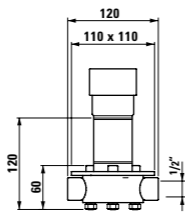

33598.7.004.264.1  
**Twin Showerstation**

Twin Showerstation

Twin Showerstation

Twin Douche combinatie

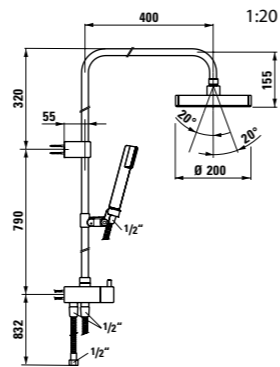

35132.1.004.220.1  
**Spültischmischer  
Patrone Quattro-G  
Ausladung 225 mm  
Schwenkauslauf**

Sink single-lever mixer  
cartridge Quattro-G  
spout reach 225 mm  
with swivel spout

Mitigeur d'évier  
cartouche Quattro-G  
saillie 225 mm  
goulot orientable

Keukenmengkraan  
keramische kardoes Quattro-G  
sprong 225 mm  
draaibare uitloop

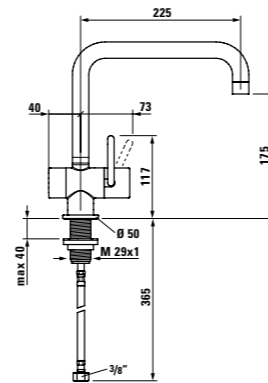

35132.1.004.320.1  
**Spültischmischer  
mit Auszugbrause  
Patrone Quattro-G  
Ausladung 225 mm  
Schwenkauslauf**

Sink single-lever mixer  
with handspray  
cartridge Quattro-G  
spout reach 225 mm  
with swivel spout

Mitigeur d'évier  
avec douchette  
cartouche Quattro-G  
saillie 225 mm  
goulot orientable

Keukenmengkraan  
met uittrekbare handdouché  
keramische kardoes Quattro-G  
sprong 225 mm  
draaibare uitloop

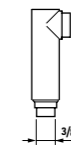
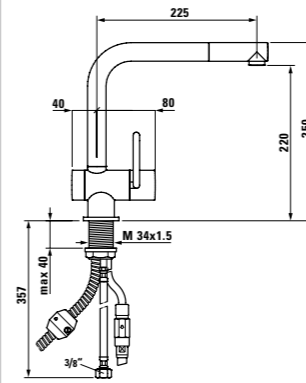

39532.0.004.302.1  
**Zugauslauf für  
Twin Spültischmischer**

Handspray for  
Twin sink single-lever mixer

Douchette d'évier Twin

Uittrekbare handdouché  
voor Twin keukenmengkraan

39598.0.004.321.1  
**Metallschlauch «force»  
L = 1500 mm**

Flexible hose «force»  
L = 1500 mm

Flexible métallique «force»  
L = 1500 mm

Flexibele metalen slang «force»  
L = 1500 mm

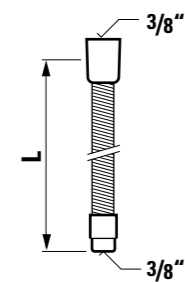

reddot design award  
winner 2010



31632.1.304.211.1  
**Elektronische Waschtischarmatur  
LumiTouch, Festauslauf 110 mm,  
mit Ablaufventil**

LumiTouch electronic basin tap, fixed  
spout 110 mm, with pop-up waste

Robinet de lavabo électronique  
LumiTouch, bec fixe 110 mm,  
avec vidage

Elektronische Wastafelmengkraan  
Lumetouch, vaste uitloop 110 mm,  
met waste

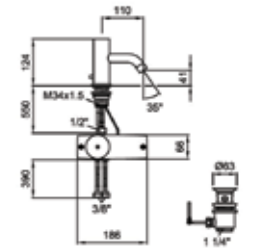



**Spültischmischer**  
Patrone Quattro-G  
flexibler Auslauf

*Sink single-lever mixer  
cartridge Quattro-G  
flexible spout*

*Mitigeur d'évier  
cartridge Quattro-G  
goulot flexible*

*Keukenmengkraan  
keramische kardoes Quattro-G  
flexibele uitloop*

3.5132.1.004.450.1  
**schwarz** / black / noir / zwart

3.5132.1.004.460.1  
**beigegrau** / beige-grey /  
grège / beigegrijs

3.5132.1.004.470.1  
**taubenblau** / pigeon blue / bleu-  
gris / duifblauw

3.5132.1.004.480.1  
**orange** / oranje

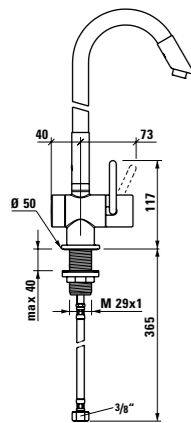

**Auslauf komplett**

bei bestehenden Twin Spültisch-  
mischern mit Schwenkauslauf  
nachrüstbar

*Spout system  
can be retrofitted to existing Twin  
sink mixers with swivel spout*

*Goulot complet  
peut être monté sur les mitigeurs  
d'évier à goulot orientable Twin  
existants*

*Complete uitloop  
voor montage op bestaande Twin  
keukenmengkranen met draaibare  
uitloop*

3.9532.0.000.341.1  
**schwarz** / black / noir / zwart

3.9532.0.000.342.1  
**beigegrau** / beige-grey /  
grège / beigegrijs

3.9532.0.000.343.1  
**taubenblau** / pigeon blue / bleu-  
gris / duifblauw

3.9532.0.000.344.1  
**orange** / oranje

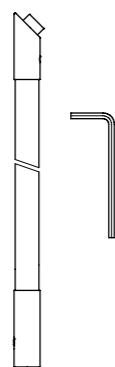

**Auslaufhülle**

für einen einfachen Wechsel der  
Farbe

*Sheats  
are available separatly and can be  
swapped quickly and easily*

*Gaine séparée  
pour un changement facile de la  
couleur*

*Uitloophuls  
om eenvoudig van kleur te  
veranderen*

3.9532.0.000.345.1  
**schwarz** / black / noir / zwart

3.9532.0.000.346.1  
**beigegrau** / beige-grey /  
grège / beigegrijs

3.9532.0.000.347.1  
**taubenblau** / pigeon blue / bleu-  
gris / duifblauw

3.9532.0.000.348.1  
**orange** / oranje

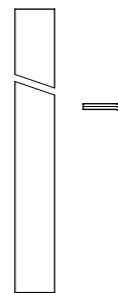

**reddot design award**  
best of the best 2008

**Asia:**

Roca Asia Ltd.  
Room 2303, 23/F  
148 Electric Road  
North Point, Hong Kong  
Tel. +852 250 624 38  
Fax +852 250 624 92  
laufenasia@hongkong.laufen.ch  
www.laufen.com/export

**Australia, New Zealand and  
Oceania:**

ROCA Bathroom Products  
Australia P/L  
Suite 304, Level 3  
191 Clarence Street  
Sydney, 2000  
NSW, Australia  
Tel. +61 (2) 9290 2331  
Fax +61 (2) 9290 2786  
josep.royo@roca.net  
www.laufen.com

**Austria:**

LAUFEN Austria AG  
Mariazeller Strasse 100  
A-3150 Wilhelmsburg  
Tel. +43 2746 6060  
Fax +43 2746 6060 380  
office@at.laufen.com  
www.laufen.co.at

**Benelux:**

LAUFEN Benelux B.V.  
Postbus 2702  
NL-3800 GG Amersfoort  
Tel. +31 (0)33 450 20 90  
Fax +31 (0)33 450 20 91  
info@laufen.nl  
www.laufen.nl

**Bulgaria:**

Roca Bulgaria AD  
5, Pirotska Str.  
1301 Sofia, Bulgaria  
Tel. +359 02 93 05 910  
Fax +359 02 93 05 918  
office.sofia@bg.roca.net  
www.roca.com

**China:**

Roca Sanitary Trading  
(Shanghai) co. Ltd  
Room 503-505, City Gateway  
No. 396 North Caoxi Road  
Shanghai 200030, China  
Tel. +86 21 3368 8822  
Fax +86 21 3368 8299  
enquiries@roca.net.cn  
www.roca.cn

**Croatia, Serbia, Bosnia,  
Herzegovina:**

LAUFEN CZ s.r.o.  
Jagodno 102  
10415 Novo Čiče  
Hrvatska  
Tel./Fax +385 1 619 56 76  
office.zagreb@hr.laufen.com  
www.laufen.com/hr

**Czech Republic:**

LAUFEN CZ s.r.o.  
V Tůních 3/1637  
120 00 Praha 2  
Tel. +420 296 337 711  
Fax +420 296 337 713  
marketing@cz.laufen.com  
www.laufen.com/cz

**Estonia, Latvia:**

LAUFEN CZ s.r.o.  
Pae 25-8  
Tallinn, 11414  
Estonia  
Tel./Fax +372 6 215 569  
office.tallinn@ee.laufen.com  
www.laufen.com

**France:**

LAUFEN France  
19-21, rue de Bretagne  
Z.I. des Béthunes  
F-95310 St-Ouen-L'Aumône Cedex  
Tel. +33 1 34 40 39 31  
Fax +33 1 30 37 02 65  
commercial@laufen-france.com  
www.laufen.com/fr

**Germany:**

Roca GmbH  
Vertrieb LAUFEN  
Feincheswiese 17  
56424 Staudt  
Tel. +49 26 02 / 94 93 33  
Fax +49 26 02 / 94 93 355  
info.staudt@de.laufen.com  
www.laufen.com/de

**Hungary:**

LAUFEN CZ s.r.o.  
Ördögárok u. 121  
H-1029 Budapest  
Magyarország  
Tel. +36 1 376 96 24  
Fax +36 1 376 96 24  
office.budapest@hu.laufen.com  
www.laufen.com

**Italy:**

LAUFEN Italia s.r.l.  
via G. Matteotti, 157  
I-20082 Binasco (MI)  
Tel. +39 02 900 16 01  
Fax +39 02 905 22 19  
info@laufen.it  
www.it.laufen.com

**Lithuania:**

LAUFEN CZ s.r.o.  
Užupio g. 30  
Vilnius, 01203  
Lietuva  
Tel. +370 5 215 30 76  
Fax +370 5 215 30 86  
office.vilnius@lt.laufen.com  
www.laufen.com/lt

**Morocco:**

Roca Maroc, S.A.  
route de Marrakech, km 2,5  
BP 571, 26000 Settlat  
Tel. +212 5 23 40 59 41  
Fax +212 5 23 40 59 42  
www.roca.com

**Nordic:**

Laufen Nordic ApS  
Torvet 15, Baghuset  
DK-4600 Køge  
Tel. +45 56 287 287  
Fax +45 56 287 237  
info@dk.laufen.com  
www.laufen.com

**North America:**

Laufen Bathrooms North America  
11190 NW 25th Street  
Miami, FL 33172  
USA  
Toll free phone +1 (866) 696-2493  
+1 (305) 357-6130  
Toll free fax +1 (866) 264-7622  
usa@laufen.com  
canada@laufen.com  
www.laufen.com/usa  
www.laufen.com/canada

**Poland:**

Roca Polska Sp. z o.o.  
ul. Wyczółkowskiego 20  
44-109 Gliwice  
Tel. +48 32 339 41 00  
Fax +48 32 339 41 01  
biuro@roca.pl  
www.laufen.pl

**Portugal:**

Roca, S.A., Portugal  
Apartado 575, Ponte da Madalena  
2416-905 - Leiria, Portugal  
Tel. +351 244 720 000  
Fax +351 244 722 373  
marketing.le@pt.roca.net  
www.laufen.pt

**Romania:**

Roca Obiecte Sanitare Srl  
1, Preciziei Blvd. District 6  
062202 Bucharest  
Tel./Fax +40 318 222 310  
Mobil +40 213 181 418

**Russia:**

Roca Rus  
Promyshlennaya Str. 7, Tosno  
Leningrad region, 187000, Russia  
Tel. +7 812 347 94 49  
Fax +7 812 347 94 50  
office.moscow@ru.laufen.com  
www.laufen.ru

Roca Rus

Elektrodnaya Str. 9,  
Moscow, 111524, Russia  
Tel. +7 495 956 33 30  
Fax +7 495 234 07 97  
office.moscow@ru.laufen.com  
www.laufen.ru

**Slovakia:**

LAUFEN SK s.r.o.  
Štefanovičova 12  
811 04 Bratislava  
Tel. +421 2 526 210 24  
Fax +421 2 526 210 25  
office.bratislava@sk.laufen.com  
www.laufen.com/sk

**Slovenia, Montenegro,  
Macedonia, Albania, Kosovo:**

LAUFEN CZ s.r.o.  
Ul. Ivana Regenta 2  
SI-6310 IZOLA, Slovenia  
Tel. +386(0)5 640 12 12  
Mob. +386(0)31 342 567  
Fax +386(0)5 640 12 12  
office.ljubljana@si.laufen.com

**Spain:**

LAUFEN  
Av Diagonal 513  
08029 Barcelona  
Tel. +34 93 366 12 00  
Fax +34 93 430 20 19  
infosan@roca.es  
www.laufen.es

**Switzerland:**

Keramik Laufen AG  
Wahlenstrasse 46  
CH-4242 Laufen  
Tel. +41 61 765 75 75  
Fax +41 61 766 56 53  
forum@laufen.ch  
www.laufen.ch

Similor AG

Wahlenstrasse 46  
CH-4242 Laufen  
Customer Service 0848 000 166  
Tel. +41 61 765 73 33  
Fax +41 61 765 73 34  
info@similorgroup.com  
www.similorgroup.com

**Ukraine:**

LAUFEN CZ s.r.o. Ukraine  
Kiev 04128  
19, Ak. Tupoleva str., office „Laufen“  
Tel. +380 44 499 0620  
Fax +380 44 499 0621  
office.kiev@ua.laufen.com  
www.laufen.net.ua

**United Kingdom and Ireland:**

LAUFEN Ltd.  
c/o Roca Ltd.  
Samson Road  
Hermitage Industrial Estate  
Coalville  
Leicestershire  
LE67 3FP  
Tel. +44 (0)1530 510007  
Fax +44 (0)1530 838949  
info@uk.laufen.com  
www.laufen.co.uk

**Export:**

LAUFEN Bathrooms AG  
Wahlenstrasse 46  
CH-4242 Laufen  
Tel. +41 61 765 76 09  
Fax +41 61 761 10 20  
export@laufen.ch  
www.laufen.com/export

**Headquarters:**

LAUFEN Bathrooms AG  
Wahlenstrasse 46  
CH-4242 Laufen  
Tel. +41 61 765 71 11  
Fax +41 61 761 36 60  
feedback@laufen.ch  
www.laufen.com

